

<b>Electrical Characteristics</b>										
Frequency	Hz	50				60				
Voltage (star)	V	380	400	415	440	415	440	460	480	
Rated power class H	kVA	12,5	12,5	12,5	10,5	13	15	15	15	
	kW	10	10	10	8,4	10,4	12	12	12	
Rated power class F	kVA	11	11	11	9	10,5	12,3	13	13	
	kW	8,8	8,8	8,8	7,2	8,4	9,8	10,4	10,4	
Regulation with SR7/2		±1,5 % with any power factor and speed variations between -5% +30%								
Insulation class		H								
Execution		Brushless								
Stator winding		6 ends								
Rotor		with damping cage								
Efficiencies class H	4/4	%	82,9	83	82,7	82,5	83,8	84,3	84,4	84,5
(see graph. for details)	3/4	%	83,2	83,5	83,4	83,1	84,4	84,6	84,8	85
	2/4	%	79,9	80	80	79,7	81,2	81,3	81,4	81,5
	1/4	%	75,1	75	74,8	74,3	75,8	75,6	75,7	76
Reactances (f. l.cl. F)	Xd	%	243,8	220	204,4	152,7	255,1	261,8	239,5	220
	Xd'	%	33,02	29,8	27,68	20,69	34,55	35,46	32,45	29,8
	Xd''	%	16,51	14,9	13,84	10,34	17,28	17,73	16,22	14,9
	Xq	%	108,6	98	91,0	68,0	113,6	116,6	106,7	98
	Xq'	%	108,6	98	91,0	68,0	113,6	116,6	106,7	98
	Xq''	%	37,3	33,7	31,3	23,4	39,1	40,1	36,7	33,7
	X <sub>2</sub>	%	17,73	16	14,86	11,11	18,55	19,04	17,42	16
	X <sub>0</sub>	%	7,09	6,4	5,95	4,44	7,42	7,62	6,97	6,4
Short Circuit Ratio	Kcc		0,39	0,51	0,72	1,34	0,26	0,34	0,39	0,51
Time Constants	Td'	sec.	0,043							
	Td''	sec.	0,01							
	Tdo'	sec.	0,65							
	Tα	sec.	0,009							
Short Circuit Current Capacity		%	>300				>320			
Excitation at no load	Amp.		0,3	0,32	0,35	0,4	0,2	0,24	0,26	0,3
Excitation at full load	Amp.		1,2	1,22	1,3	1,4	0,9	1	1,1	1,2
Overload (long-term)		%	1 hour in a 6 hours period 110% rated load							
Overload per 20 sec.		%	300							
Stator Winding Resistance (20°C)	Ω		0,678							
Rotor Winding Resistance (20°C)	Ω		8,238							
Exciter Resistance (20 °C)	Ω		Rotor : 1,453				Stator : 15,71			
Heat dissipation at f.l.cl.H	W		2063	2048	2092	1782	2011	2235	2218	2201
Telephone Interference			THF < 2 %				TIF < 45			
Radio interference			EN50081-1, EN50082-1, VDE0875K. For others standards apply to factory							
Waveform Distors.(THD) at f. load	LL/LN %		4,7 / 4,5							
Waveform Distors.(THD) at no load	LL/LN %		4 / 4							
<b>Mechanical characteristics</b>										
Protection			IP 23 (other protection on request)							
DE bearing			6308-2RS							
NDE bearing			6305-2RS							
Weight of wound stator assembly	kg		21,2							
Weight of wound rotor assembly	kg		11,5							
Weight of complete generator	kg		69							
Maximun overspeed	rpm		4500							
Unbalanced magnetic pull at f.l.cl.F	kN/mm		2,8							
Cooling air requirement	m³/min		6,2				7,8			
Inertia Constant (H)	sec.		0,254				0,305			
Noise level at 1m/7m	dB(A)		85 / 70				89 / 73			

**50 Hz**

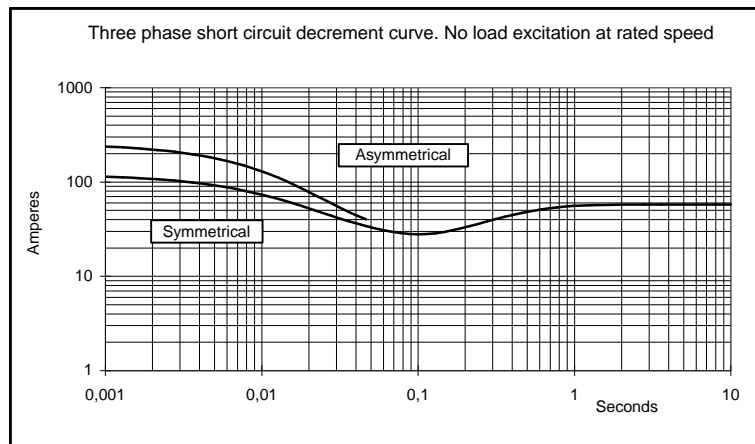

**60 Hz**

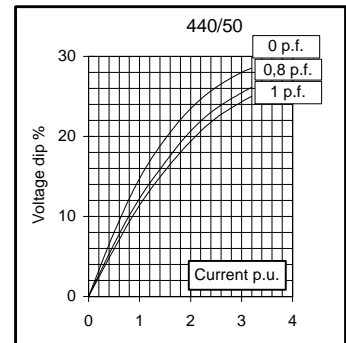
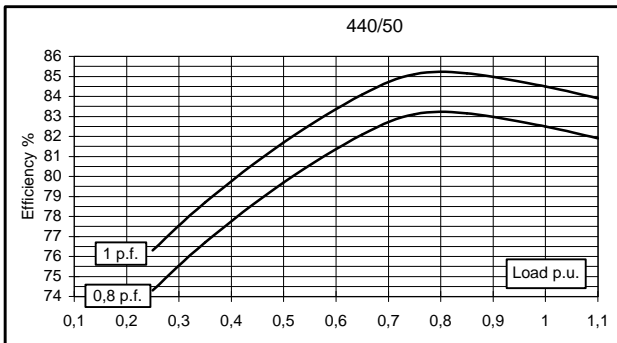
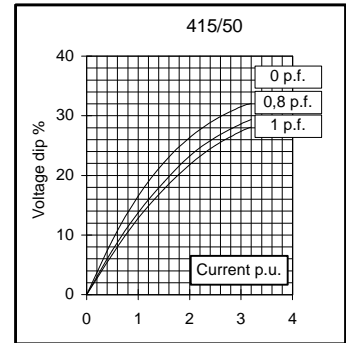
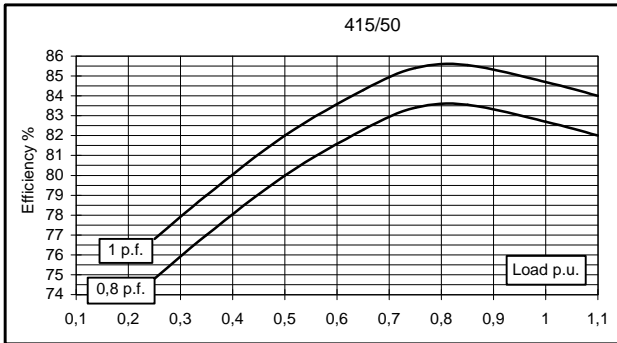
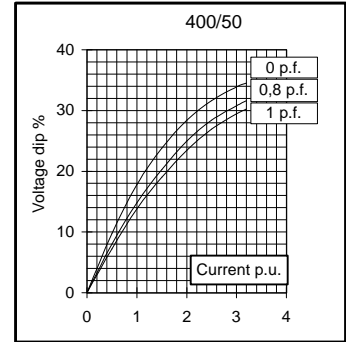
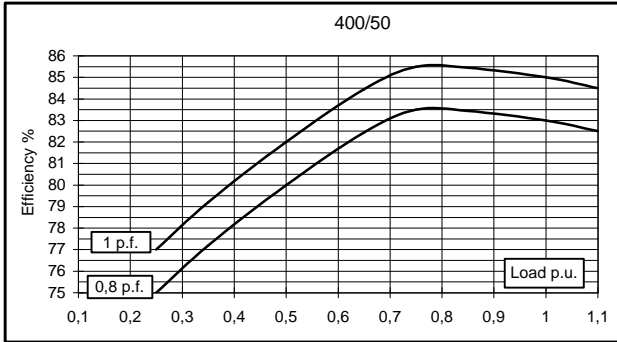
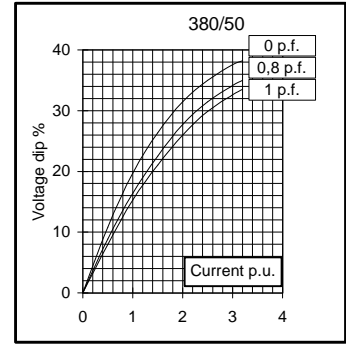
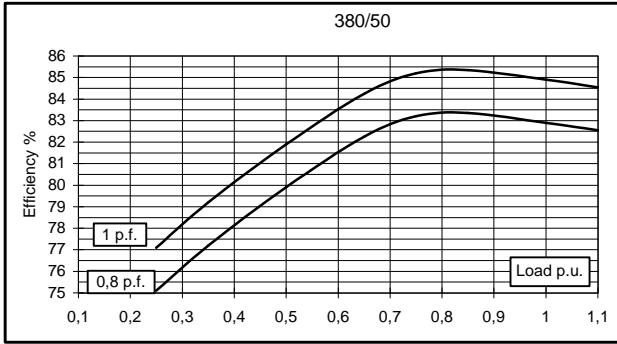
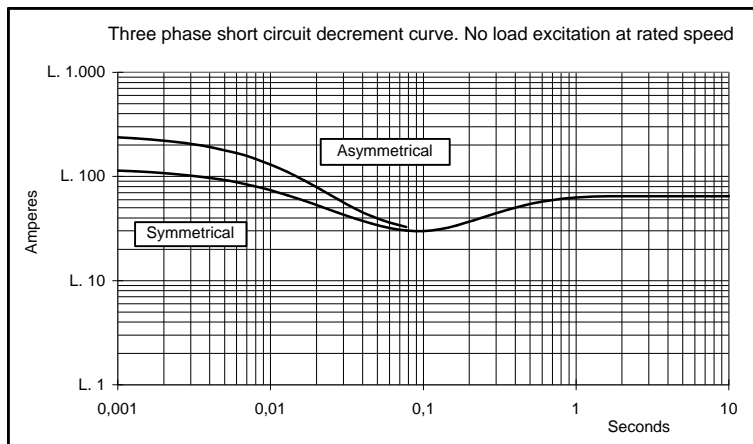
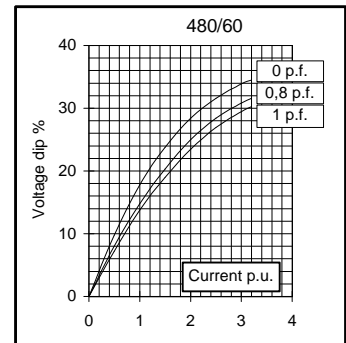
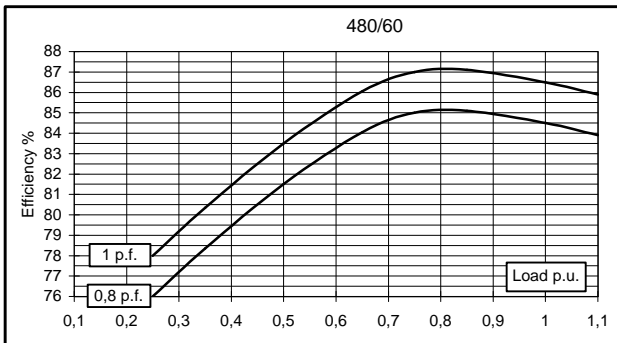
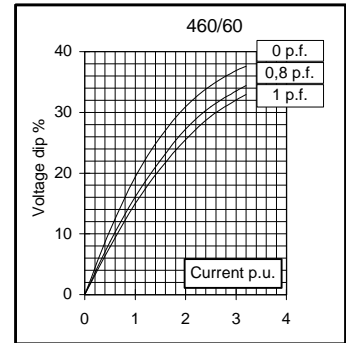
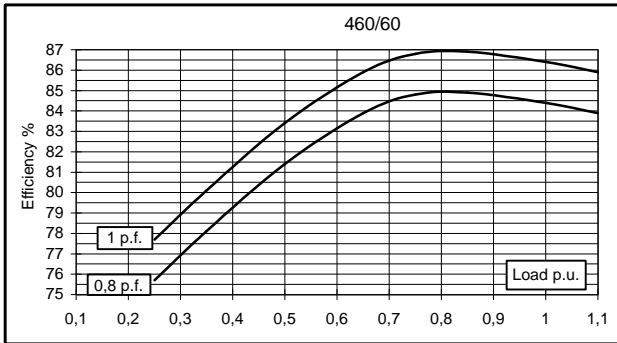
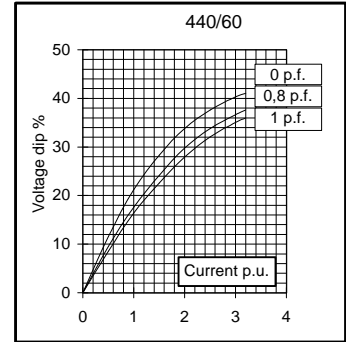
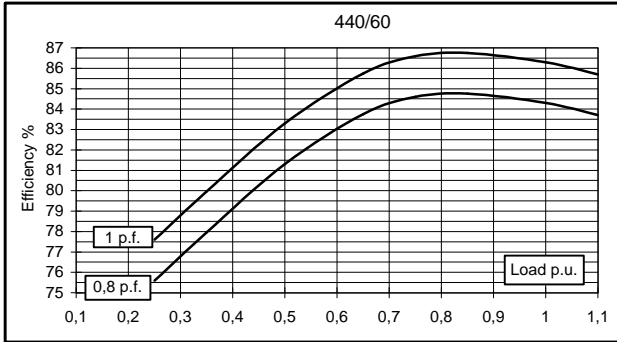
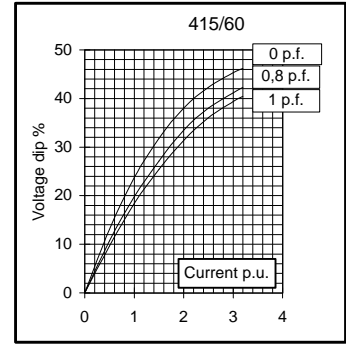
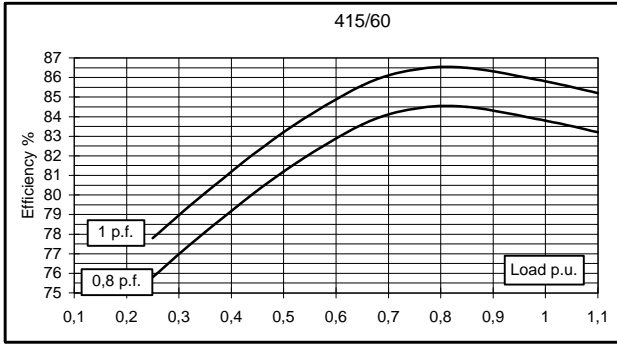

## TWO BEARING MOMENTS OF INERTIA

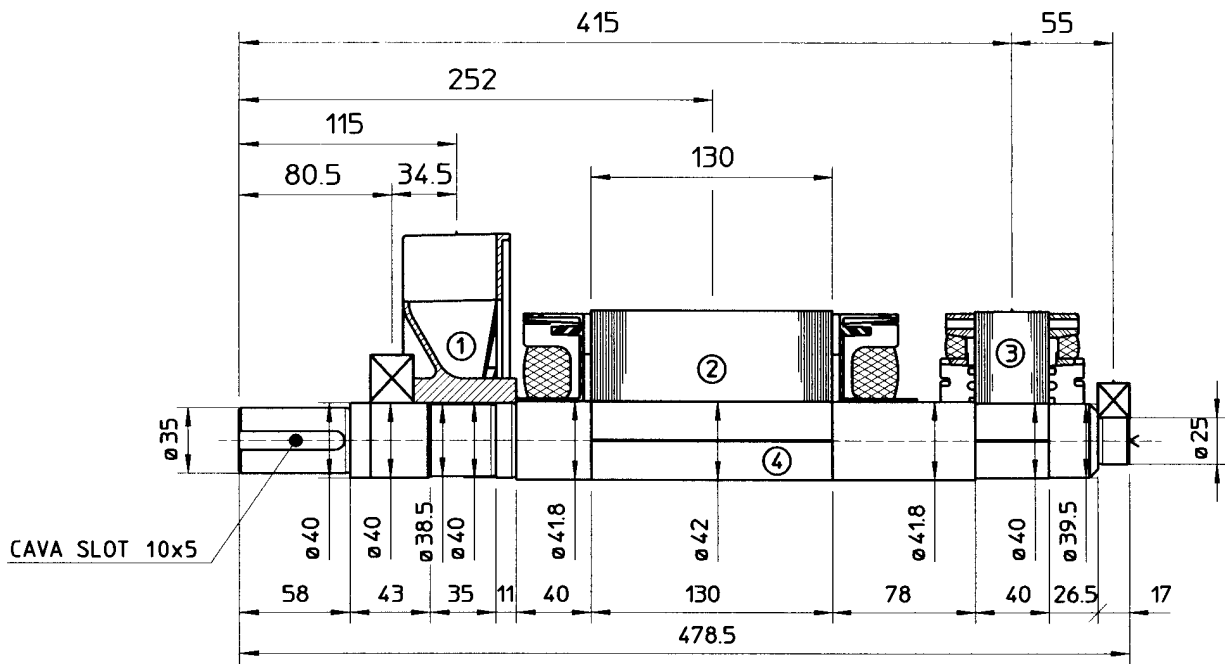

COMPONENT	WEIGHT Kg	J Kgm <sup>2</sup>
1 FAN	0.93	0.0036
2 MAIN ROTOR	12.42	0.029
3 EX ROTOR	4.12	0.011
4 SHAFT	4.7	0.00097
6 TOTAL	22.17	0.04457

## TWO BEARING DIMENSIONS

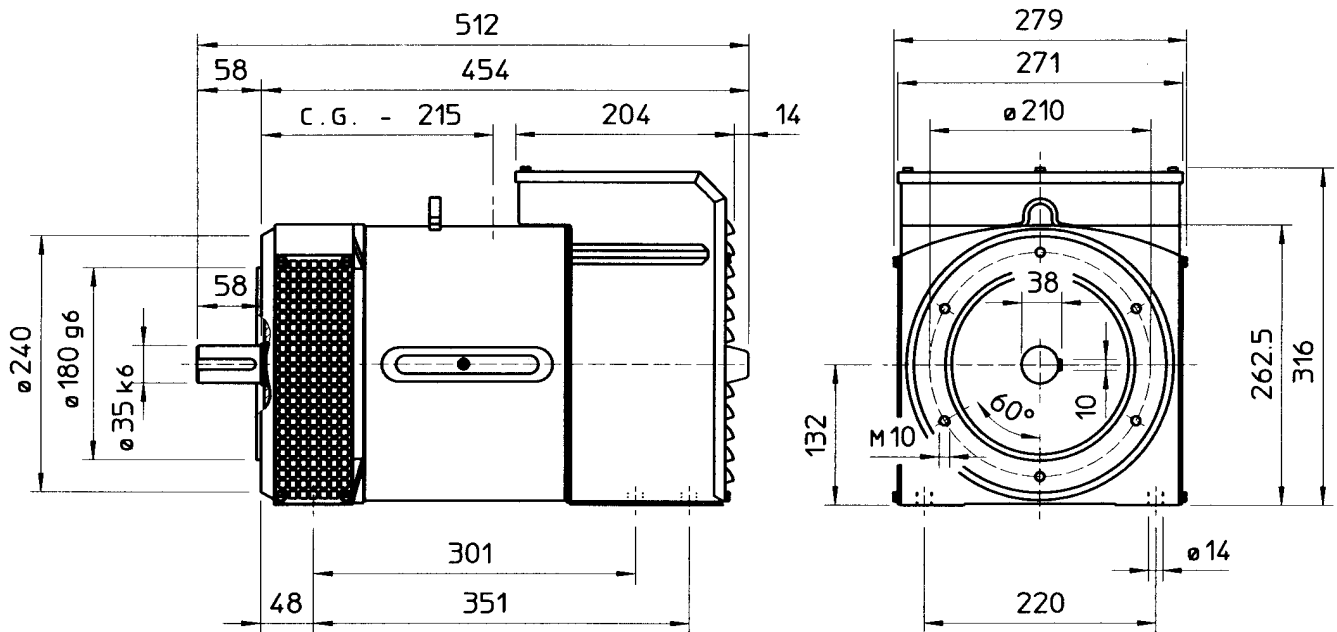

# SINGLE BEARING MOMENTS OF INERTIA

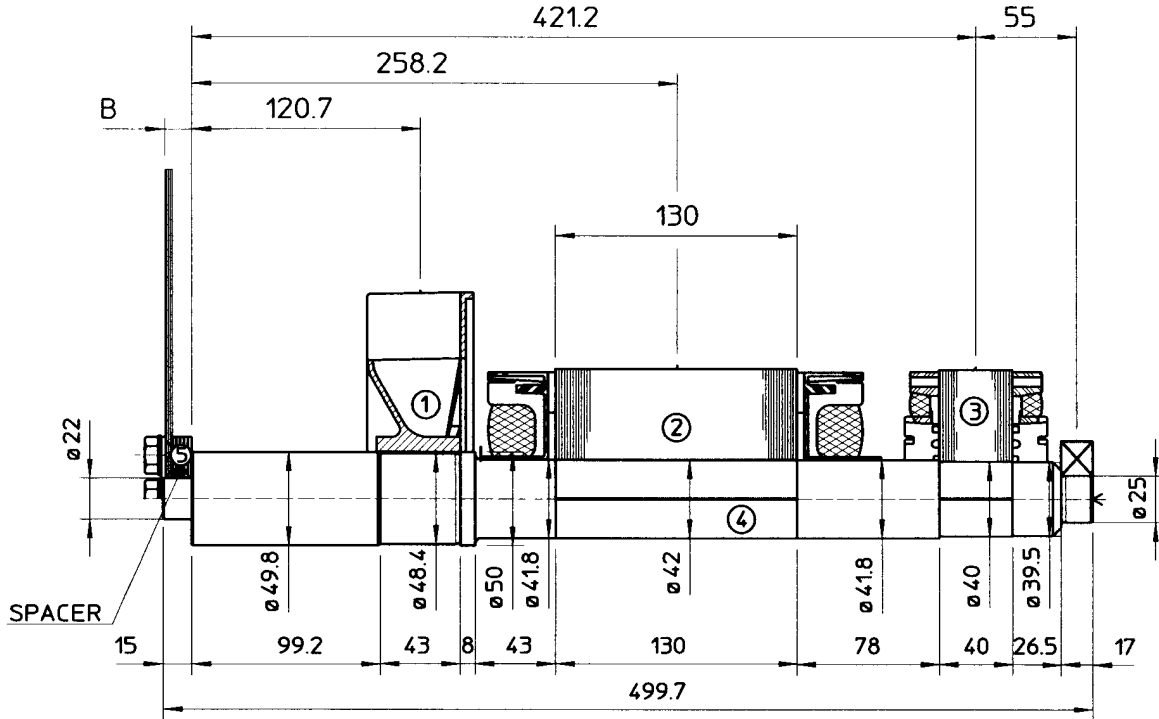

COMPONENT	WEIGHT Kg	J Kg <sup>m</sup> <sup>2</sup>
1 FAN	0.82	0.0032
2 MAIN ROTOR	12.42	0.029
3 EX ROTOR	4.12	0.011
4 SHAFT	5.6	0.0012
6 TOTAL	22.96	0.0444

SAE N.	5 B (mm)	SHAFT COUPLING FLEX PLATE WEIGHT kg	J kg <sup>m</sup> <sup>2</sup>
6 1/2	4	1.14	0.0067
7 1/2	4	1.42	0.0103
8	35.6	1.97	0.0171
10	27.6	2.59	0.0319
11 1/2	14	3.1	0.0481

# SINGLE BEARING DIMENSIONS

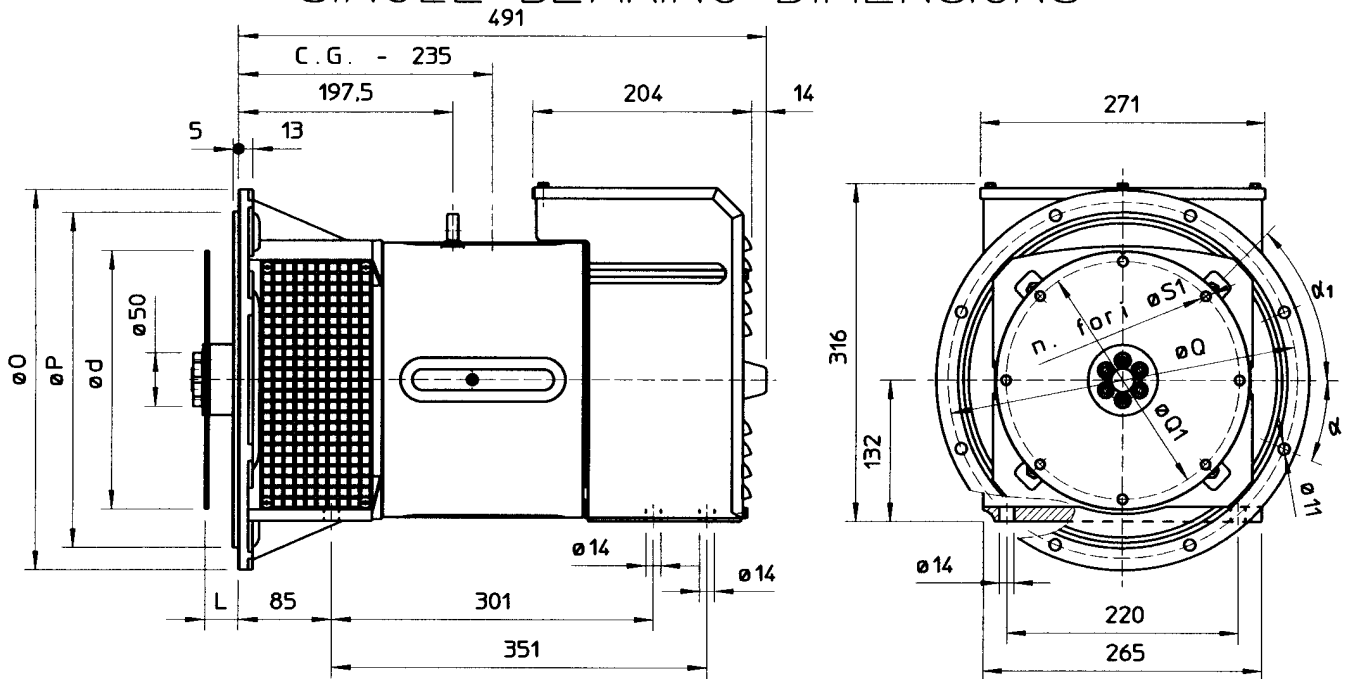

GIUNTI A DISCO COUPLING DISC PLATEX  
DISQUE DE MONOPALIER SCHEIBENKUPPLUNG  
JUNTAS A DISCOS

FLANGIA FLANGE BRIDE FLANSCH BRIDAS	SAE N.	O	P	Q	n. fori	α
	6	308	266.7	285.75	8	22°30'
	5	356	314.3	333.4	8	22°30'
	4	403	362	381	12	15°
	3	451	409.6	428.6	12	15°

SAE N.	L	d	Q1	n. fori	S1	α1
6 1/2	30.2	215.9	200	6	9	60°
7 1/2	30.2	241.3	222.25	8	9	45°
8	62	263.52	244.47	6	11	60°
10	53.8	314.32	295.27	8	11	45°
11 1/2	39.6	352.42	333.37	8	11	45°

C.G. = GRAVITY CENTER