

Electrical Characteristics										
Frequency	Hz	50				60				
Voltage (star)	V	380	400	415	440	415	440	460	480	
Rated power class H	kVA	19	19	19	15	20	22,8	22,8	22,8	
	kW	15,2	15,2	15,2	12	16	18,2	18,2	18,2	
Rated power class F	kVA	17	17	17	13,4	17	19,5	20,5	20,5	
	kW	13,6	13,6	13,6	10,7	13,6	15,6	16,4	16,4	
Regulation with	SR7/2	±1,5 % with any power factor and speed variations between -5% +30%								
Insulation class		H								
Execution		Brushless								
Stator winding		6 ends								
Rotor		with damping cage								
Efficiencies class H	4/4	%	85,4	85,5	85,2	85	86,5	87	87,1	87,2
(see graph. for details)	3/4	%	85,7	86	85,9	85,6	87,2	87,4	87,6	87,8
	2/4	%	82,4	82,5	82,5	82,2	84,2	84,3	84,4	84,5
	1/4	%	78,1	78	77,8	77,3	79,3	79,1	79,2	79,5
Reactances (f. l.cl. F)	Xd	%	213,9	193	179,3	125,9	226,5	229,7	210,1	193
	Xd'	%	29,47	26,6	24,71	17,36	31,21	31,66	28,96	26,6
	Xd''	%	16,07	14,5	13,47	9,46	17,02	17,26	15,79	14,5
	Xq	%	111,9	101	93,8	65,9	118,5	120,2	110,0	101
	Xq'	%	111,9	101	93,8	65,9	118,5	120,2	110,0	101
	Xq''	%	40,4	36,5	33,9	23,8	42,8	43,4	39,7	36,5
	X ₂	%	19,72	17,8	16,54	11,61	20,89	21,18	19,38	17,8
	X ₀	%	6,09	5,5	5,11	3,59	6,45	6,55	5,99	5,5
Short Circuit Ratio	Kcc		0,51	0,63	0,84	1,46	0,38	0,46	0,51	0,63
Time Constants	Td'	sec.	0,055							
	Td''	sec.	0,011							
	Tdo'	sec.	0,70							
	Tα	sec.	0,01							
Short Circuit Current Capacity		%	>300				>320			
Excitation at no load	Amp.		0,32	0,35	0,4	0,45	0,2	0,27	0,3	0,33
Excitation at full load	Amp.		1,2	1,27	1,3	1,4	1	1,04	1,1	1,2
Overload (long-term)		%	1 hour in a 6 hours period 110% rated load							
Overload per 20 sec.		%	300							
Stator Winding Resistance (20°C)	Ω		0,443							
Rotor Winding Resistance (20°C)	Ω		9,627							
Exciter Resistance (20 °C)	Ω		Rotor : 1,453				Stator : 15,71			
Heat dissipation at f.l.cl.H	W		2599	2578	2640	2118	2497	2726	2701	2677
Telephone Interference			THF < 2%				TIF < 45			
Radio interference			EN50081-1, EN50082-1, VDE0875K. For others standards apply to factory							
Waveform Distors.(THD) at f. load	LL/LN %		4,7 / 4,4							
Waveform Distors.(THD) at no load	LL/LN %		3,6 / 3,4							
Mechanical characteristics										
Protection			IP 23 (other protection on request)							
DE bearing			6308-2RS							
NDE bearing			6305-2RS							
Weight of wound stator assembly	kg		25,8							
Weight of wound rotor assembly	kg		14							
Weight of complete generator	kg		84							
Maximun overspeed	rpm		4500							
Unbalanced magnetic pull at f.l.cl.F	kN/mm		3,1							
Cooling air requirement	m³/min		5,8				6,8			
Inertia Constant (H)	sec.		0,148				0,177			
Noise level at 1m/7m	dB(A)		85 / 70				89 / 73			

50 Hz

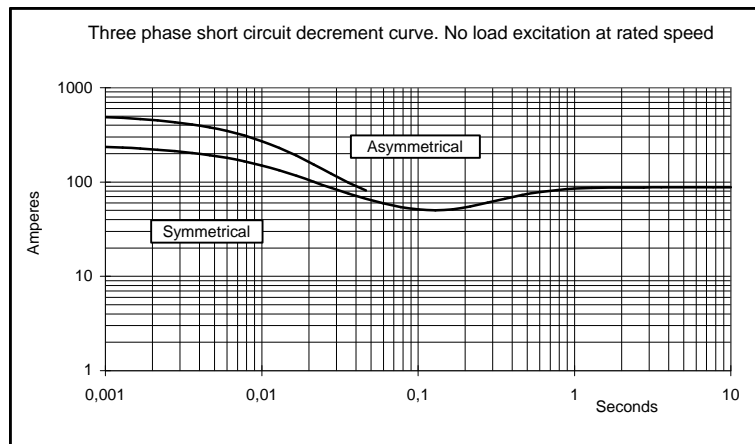

60 Hz

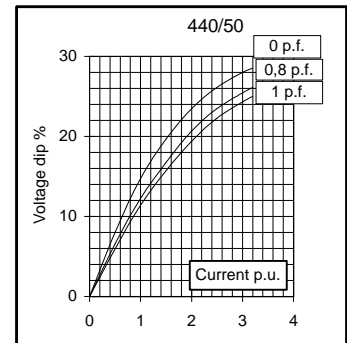
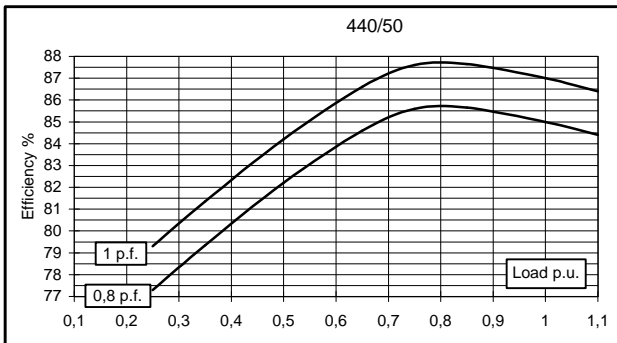
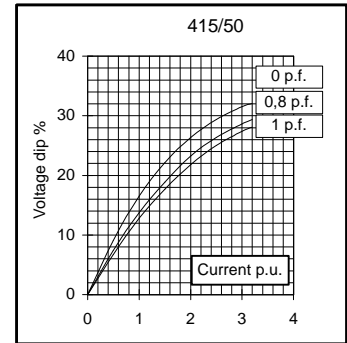
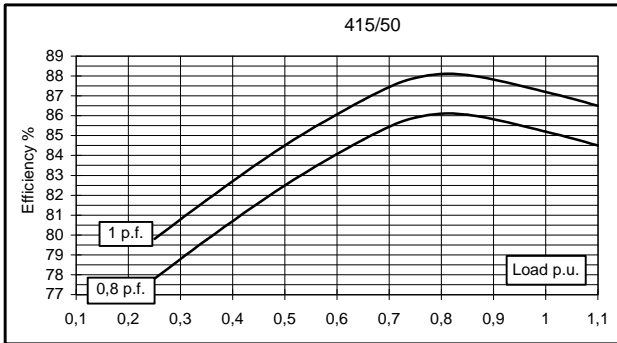
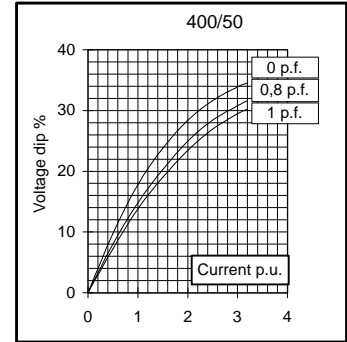
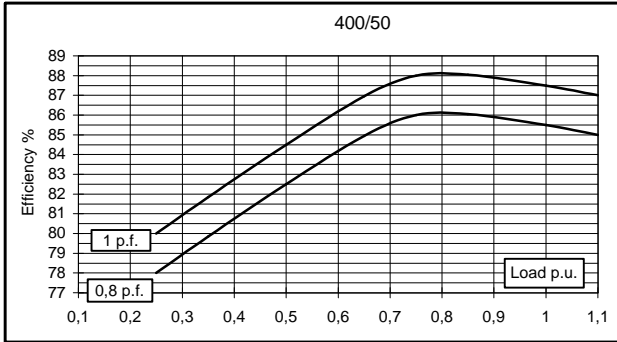
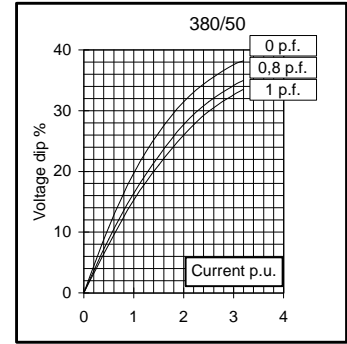
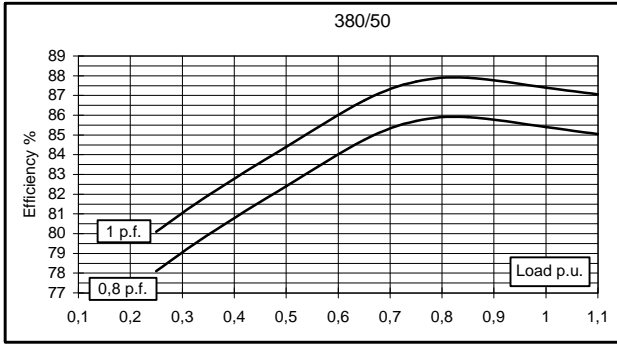
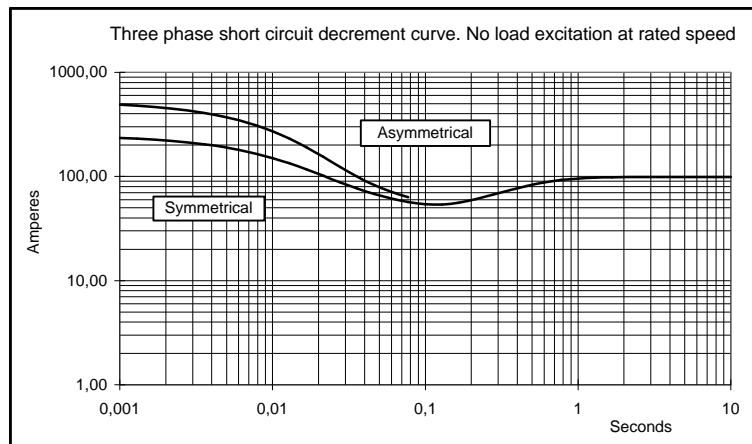
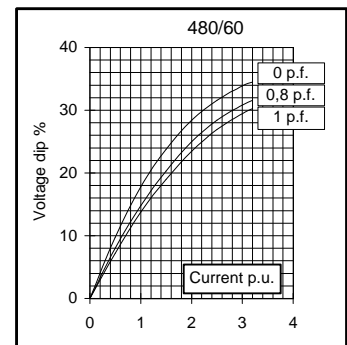
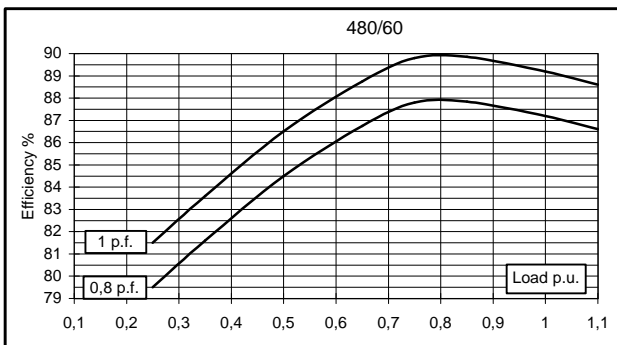
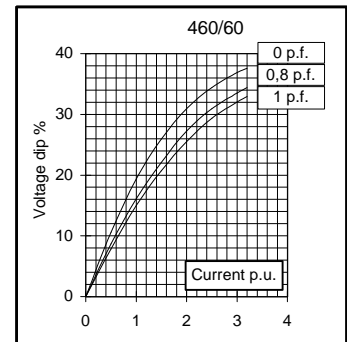
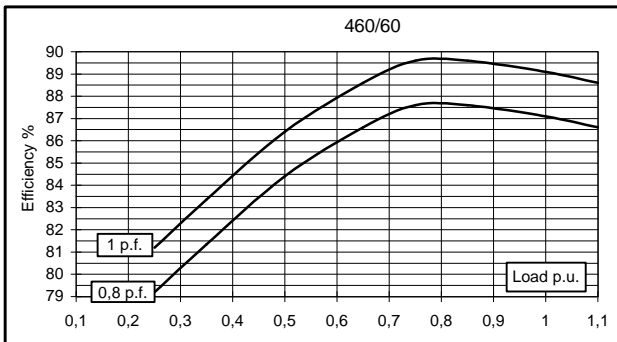
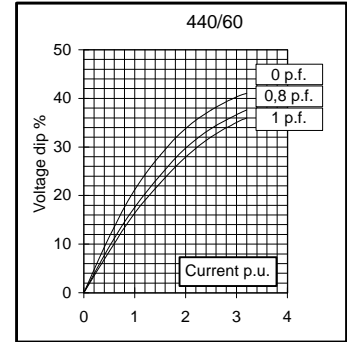
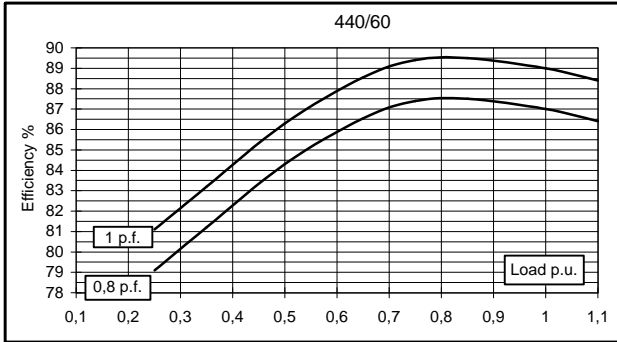
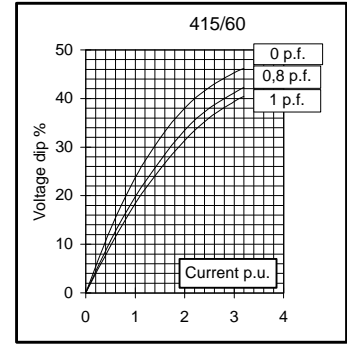
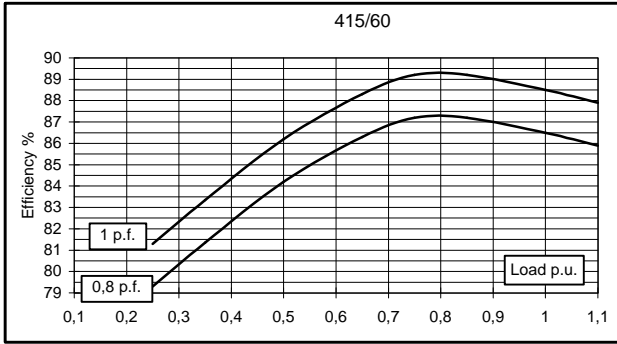

TWO BEARING MOMENTS OF INERTIA

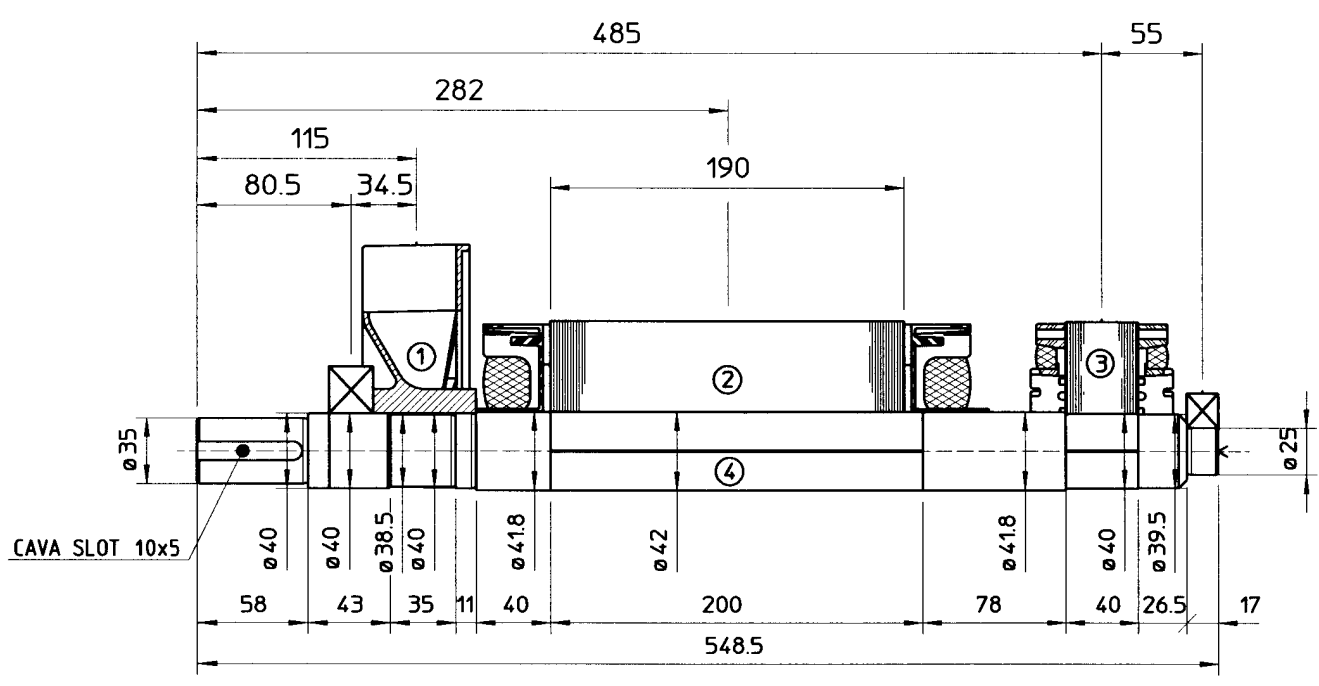

COMPONENT	WEIGHT Kg	J Kg ^m ²
1 FAN	0.93	0.0036
2 MAIN ROTOR	17.2	0.041
3 EX ROTOR	4.12	0.011
4 SHAFT	5.5	0.0011
6 TOTAL	27.75	0.0567

TWO BEARING DIMENSIONS

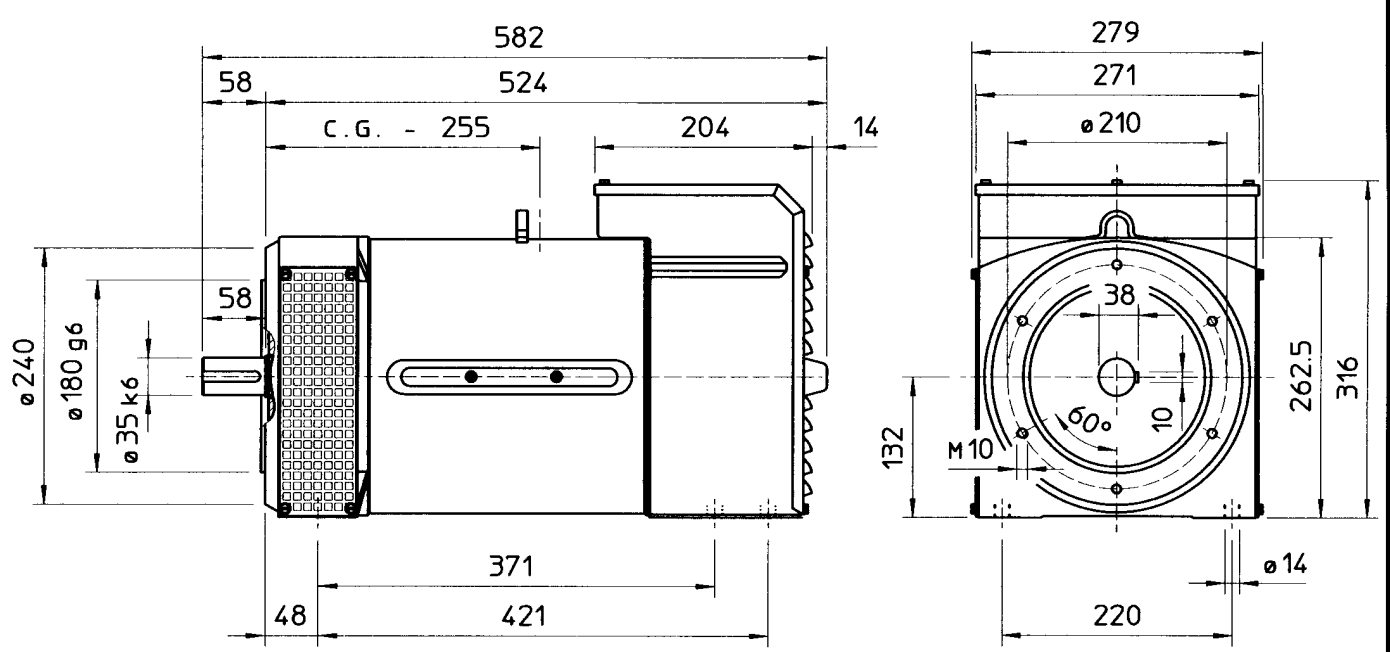

C.G. - GRAVITY CENTER

