

Electrical Characteristics										
Frequency	Hz	50				60				
Voltage (star)	V	380	400	415	440	415	440	460	480	
Rated power class H	kVA	16	16	16	13	17	19,2	19,2	19,2	
	kW	12,8	12,8	12,8	10,4	13,6	15,4	15,4	15,4	
Rated power class F	kVA	14,5	14,5	14,5	11,5	14	16,2	17	17	
	kW	11,6	11,6	11,6	9,2	11,2	13	13,6	13,6	
Regulation with SR7/2		±1,5 % with any power factor and speed variations between -5% +30%								
Insulation class		H								
Execution		Brushless								
Stator winding		6 ends								
Rotor		with damping cage								
Efficiencies class H	4/4	%	84,4	84,5	84,2	84	85,4	85,9	86	86,1
(see graph. for details)	3/4	%	84,7	85	84,9	84,6	86	86,2	86,4	86,6
	2/4	%	81,4	81,5	81,5	81,2	83,2	83,3	83,4	83,5
	1/4	%	77,1	77	76,8	76,3	77,8	77,6	77,7	78
Reactances (f. l.cl. F)	Xd	%	223,8	202	187,7	135,6	239,3	240,4	219,9	202
	Xd'	%	30,91	27,9	25,92	18,73	33,05	33,20	30,38	27,9
	Xd''	%	16,73	15,1	14,03	10,14	17,89	17,97	16,44	15,1
	Xq	%	110,1	99,4	92,3	66,7	117,7	118,3	108,2	99,4
	Xq'	%	110,1	99,4	92,3	66,7	117,7	118,3	108,2	99,4
	Xq''	%	42,3	38,2	35,5	25,7	45,2	45,5	41,6	38,2
	X ₂	%	19,39	17,5	16,26	11,75	20,73	20,83	19,05	17,5
	X ₀	%	6,65	6	5,57	4,03	7,11	7,14	6,53	6
Short Circuit Ratio	Kcc		0,43	0,55	0,76	1,38	0,30	0,38	0,43	0,55
Time Constants	Td'	sec.	0,062							
	Td''	sec.	0,014							
	Tdo'	sec.	0,67							
	Tα	sec.	0,012							
Short Circuit Current Capacity		%	>300				>320			
Excitation at no load	Amp.		0,25	0,3	0,37	0,4	0,18	0,2	0,24	0,28
Excitation at full load	Amp.		1,1	1,2	1,25	1,3	0,95	1	1,05	1,1
Overload (long-term)		%	1 hour in a 6 hours period 110% rated load							
Overload per 20 sec.		%	300							
Stator Winding Resistance (20°C)	Ω		0,512							
Rotor Winding Resistance (20°C)	Ω		9,487							
Exciter Resistance (20 °C)	Ω		Rotor : 1,453				Stator : 15,71			
Heat dissipation at f.l.cl.H	W		2366	2348	2402	1981	2325	2521	2500	2480
Telephone Interference			THF < 2%				TIF < 45			
Radio interference			EN50081-1, EN50082-1, VDE0875K. For others standards apply to factory							
Waveform Distors.(THD) at f. load	LL/LN %		4,6/ 4,4							
Waveform Distors.(THD) at no load	LL/LN %		3,8/ 3,7							
Mechanical characteristics										
Protection			IP 23 (other protection on request)							
DE bearing			6308-2RS							
NDE bearing			6305-2RS							
Weight of wound stator assembly	kg		24							
Weight of wound rotor assembly	kg		13							
Weight of complete generator	kg		78							
Maximun overspeed	rpm		4500							
Unbalanced magnetic pull at f.l.cl.F	kN/mm		2,9							
Cooling air requirement	m³/min		6				7,2			
Inertia Constant (H)	sec.		0,157				0,188			
Noise level at 1m/7m	dB(A)		85 / 70				89 / 73			

50 Hz

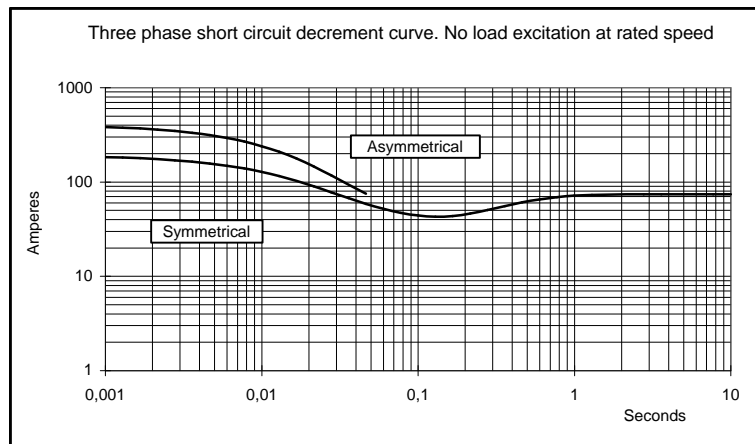

60 Hz

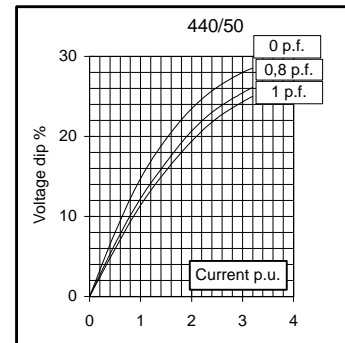
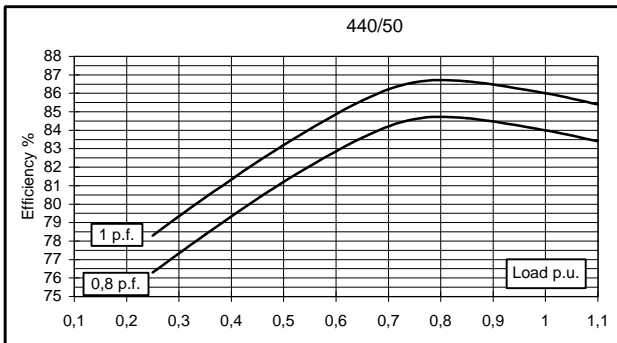
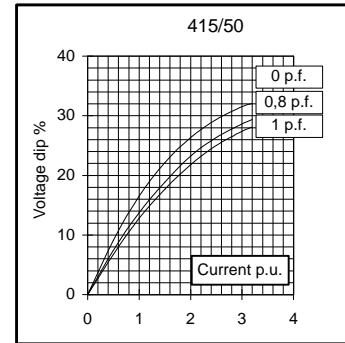
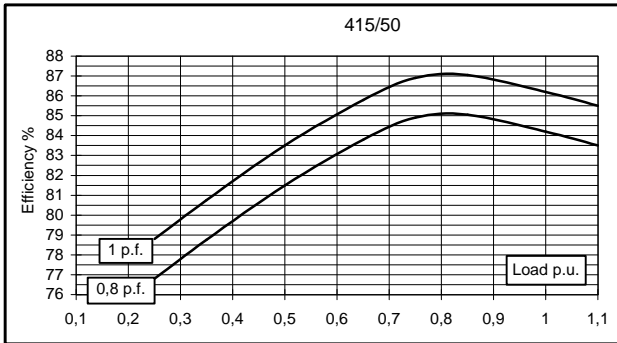
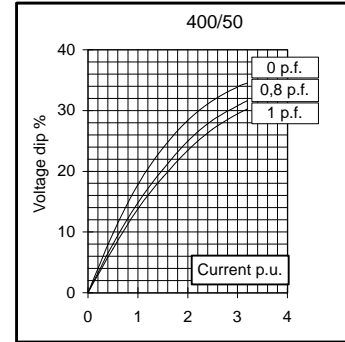
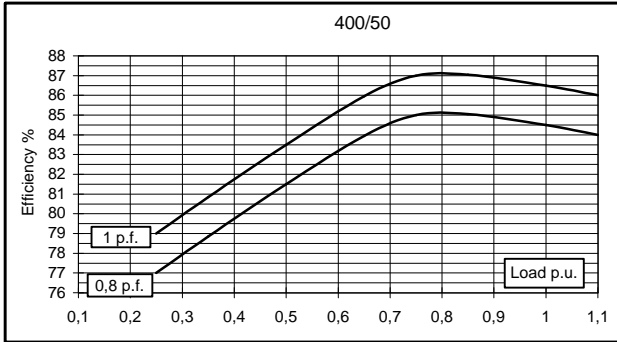
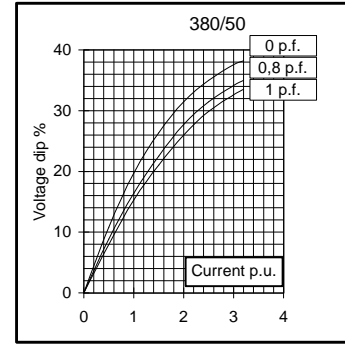
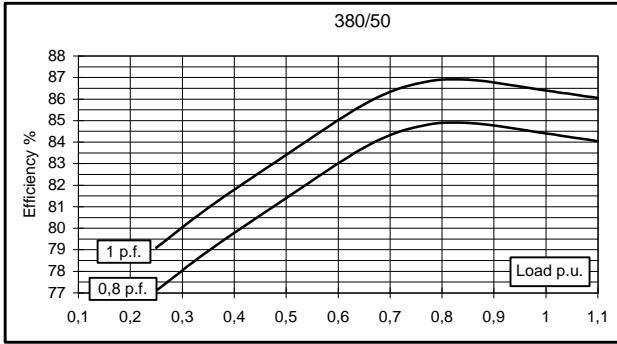
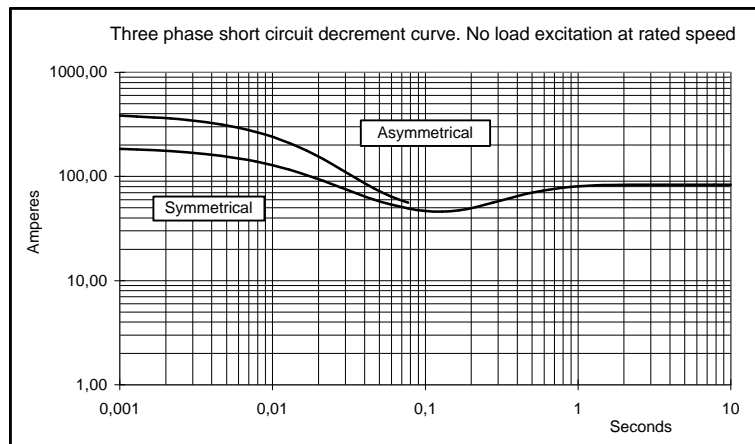
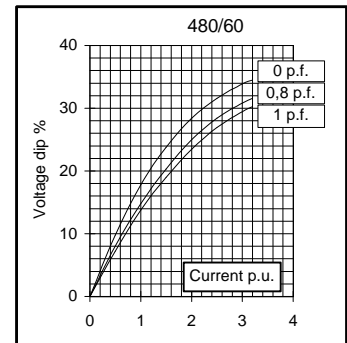
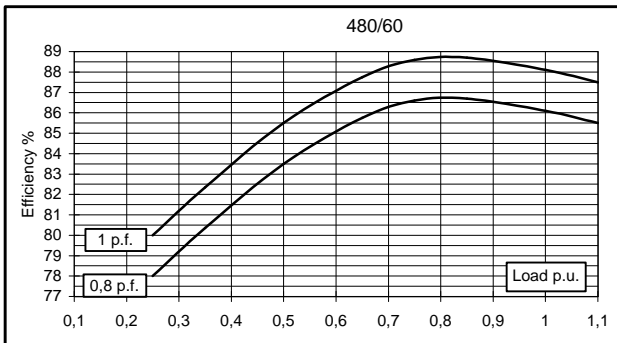
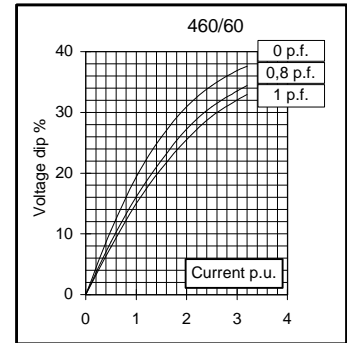
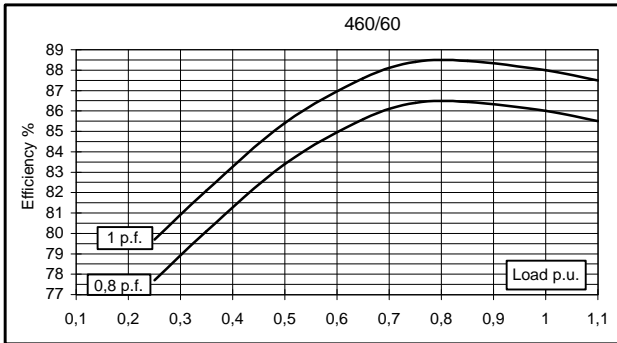
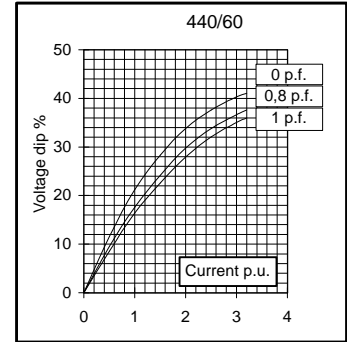
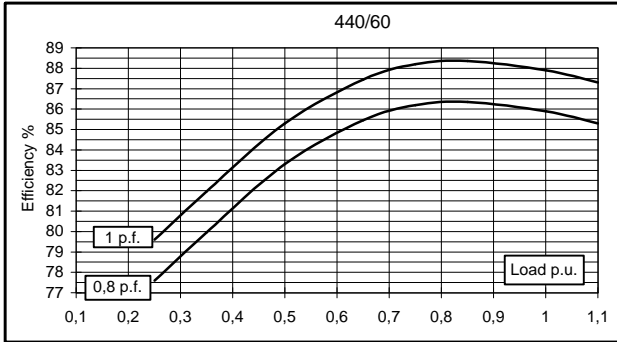
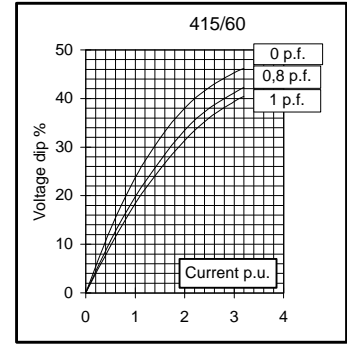
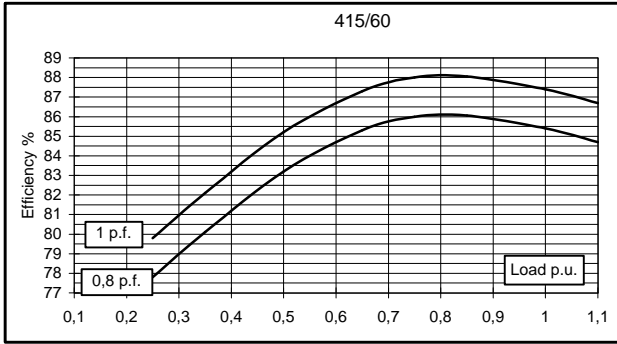

TWO BEARING MOMENTS OF INERTIA

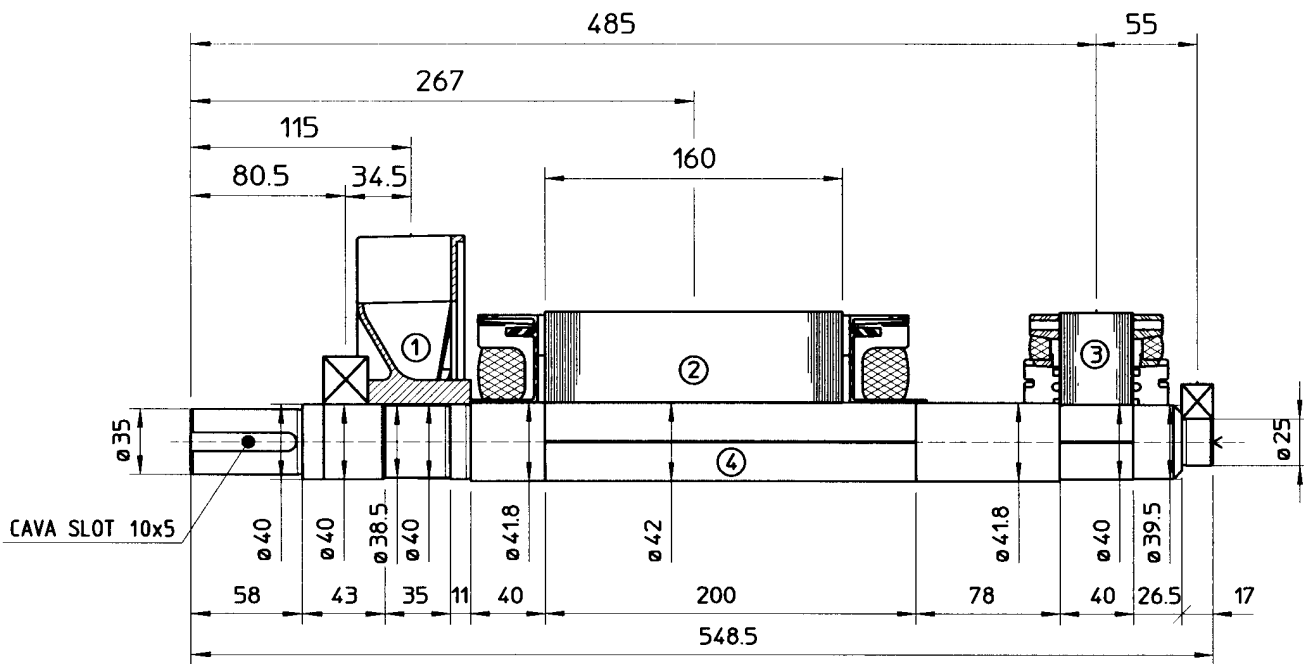

COMPONENT	WEIGHT Kg	J Kg ^m ²
1 FAN	0.93	0.0036
2 MAIN ROTOR	14.72	0.035
3 EX ROTOR	4.12	0.011
4 SHAFT	5.5	0.0011
6 TOTAL	25.27	0.0507

TWO BEARING DIMENSIONS

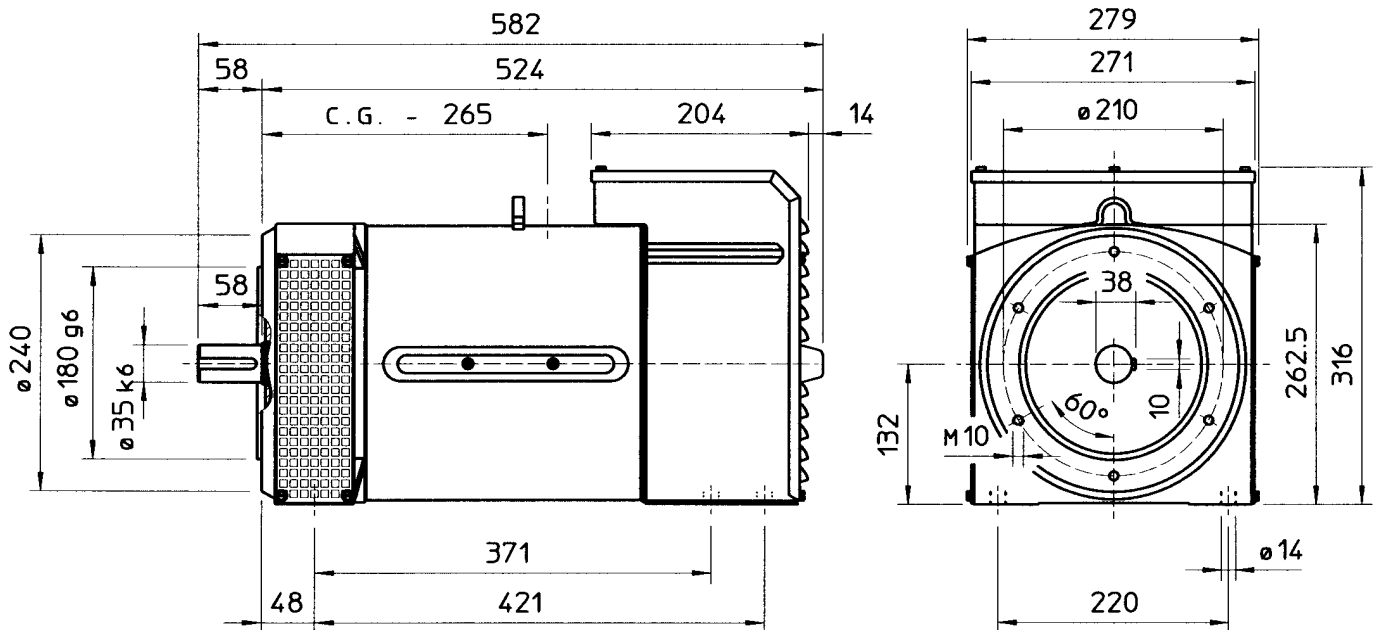

SINGLE BEARING MOMENTS OF INERTIA

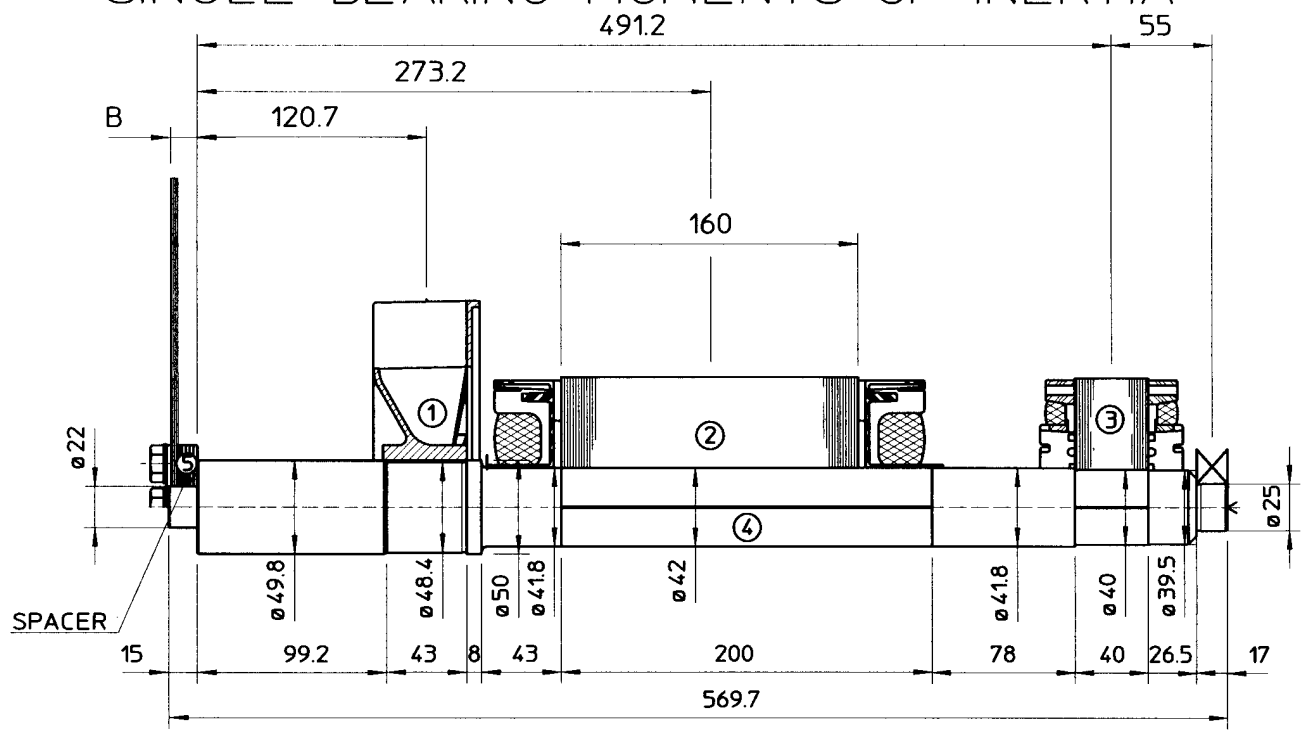

COMPONENT	WEIGHT Kg	J Kg ^{m²}
1 FAN	0.82	0.0032
2 MAIN ROTOR	14.72	0.035
3 EX ROTOR	4.12	0.011
4 SHAFT	6.3	0.0013
6 TOTAL	25.96	0.0505

SAE N.	5 B (mm)	SHAFT COUPLING FLEX PLATE WEIGHT kg	J kg ^{m²}
6 1/2	4	1.14	0.0067
7 1/2	4	1.42	0.0103
8	35.6	1.97	0.0171
10	27.6	2.59	0.0319
11 1/2	14	3.1	0.0481

SINGLE BEARING DIMENSIONS

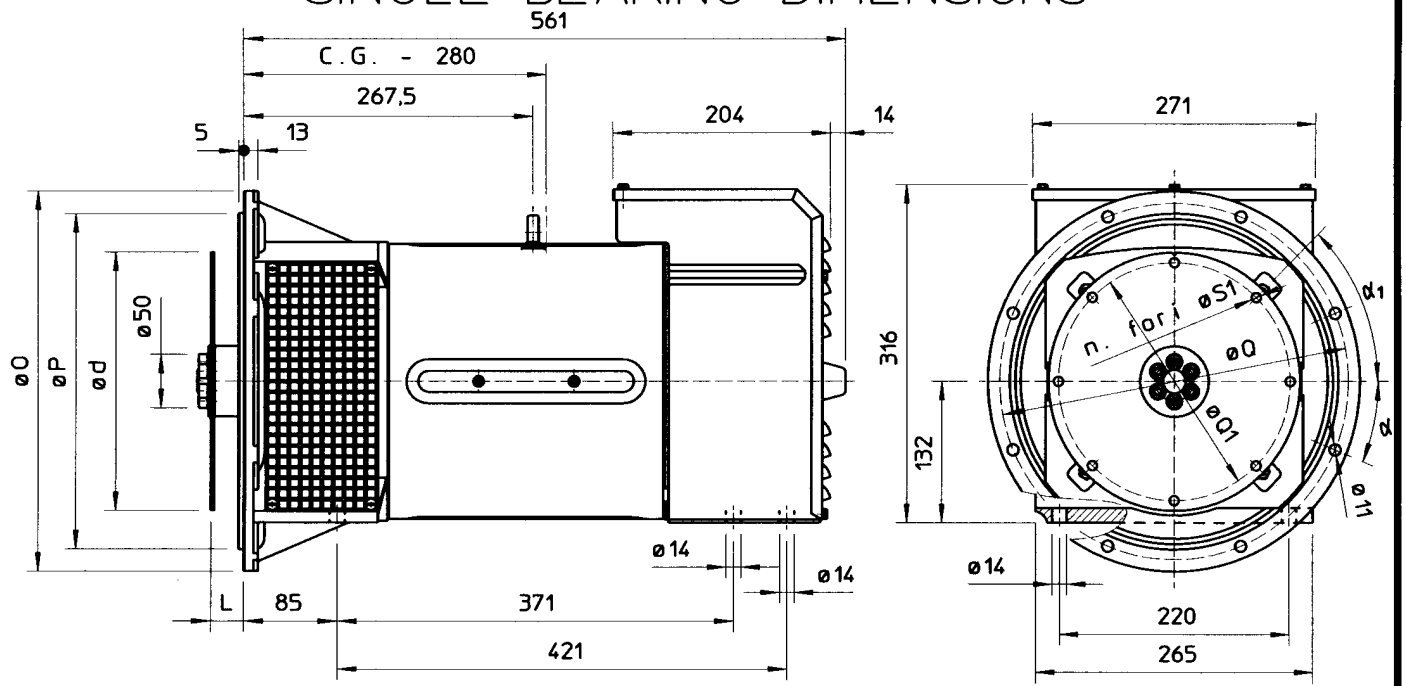

GIUNTI A DISCO COUPLING DISC PLATEX
DISQUE DE MONOPALIER SCHEIBENKUPPLUNG
JUNTAS A DISCOS

FLANGIA FLANGE BRIDE FLANSCH BRIDAS	SAE N.	O	P	Q	n. fori	α
	6	308	266.7	285.75	8	22°30'
	5	356	314.3	333.4	8	22°30'
	4	403	362	381	12	15°
	3	451	409.6	428.6	12	15°

SAE N.	L	d	Q1	n. fori	S1	α1
6 1/2	30.2	215.9	200	6	9	60°
7 1/2	30.2	241.3	222.25	8	9	45°
8	62	263.52	244.47	6	11	60°
10	53.8	314.32	295.27	8	11	45°
11 1/2	39.6	352.42	333.37	8	11	45°

C.G. - GRAVITY CENTER