

L1-L2: 240V
 N-L1: 120V
 N-L2: 120V

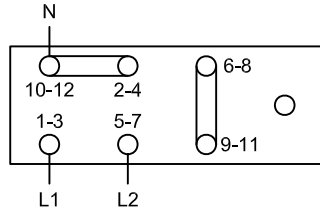

1 PHASE ZIG-ZAG

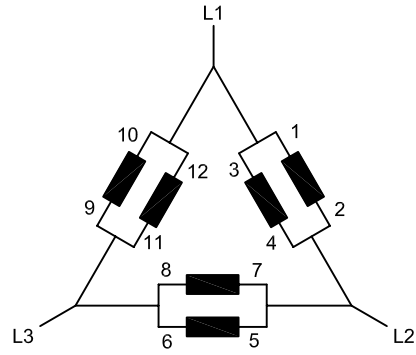

L1-L2-L3: 208V 3Ø
 L1-L2: 208V
 L1-L3: 208V
 L2-L3: 208V

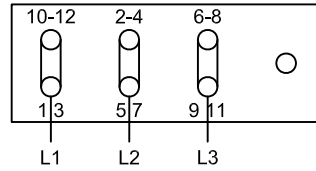

PARALLEL DELTA

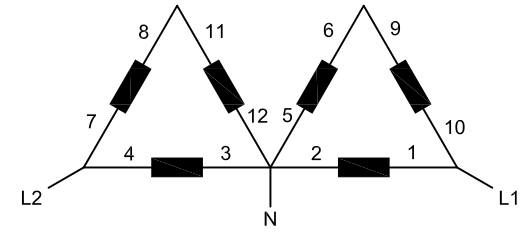

L1-L2: 240V
 N-L1: 120V
 N-L2: 120V

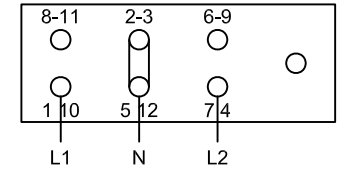

DOUBLE DELTA

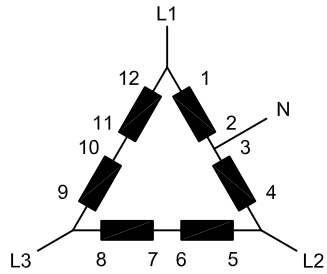

L1-L2-L3: 240V 3Ø
 L1-L2: 240V
 L1-L3: 240V
 L2-L3: 240V
 N-L1: 120V
 N-L2: 120V

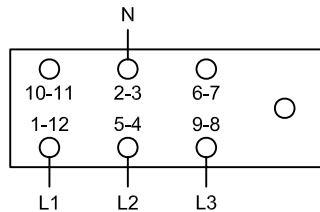

SERIES DELTA

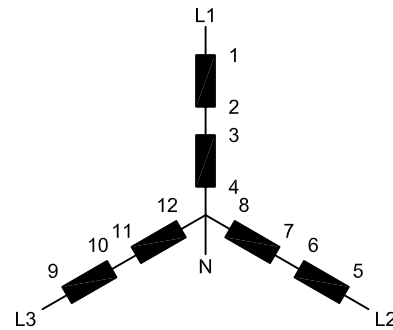

L1-L2-L3: 480V 3Ø
 L1-L2: 480V
 L1-L3: 480V
 L2-L3: 480V
 N-L1: 277V
 N-L2: 277V
 N-L3: 277V

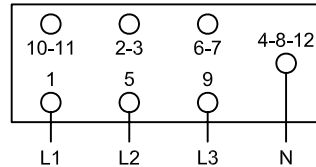

SERIES STAR

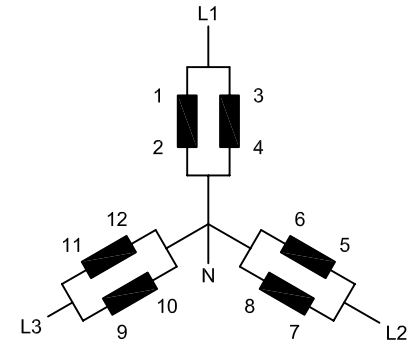

L1-L2-L3: 208V 3Ø
 L1-L2: 208V
 L1-L3: 208V
 L2-L3: 208V
 N-L1: 120V
 N-L2: 120V
 N-L3: 120V

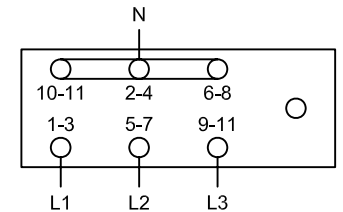

PARALLEL STAR

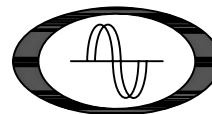

TITLE
 HOOK UP DIAGRAMS, GENERATORS, 60 HZ

DOCUMENT NUMBER
 MC11445

SIZE
 A