



LOMBARDINI[®]
USA Inc.

"Your Partner, Not Your Competitor"

LDW 702 FOCS PLUS

Low Speed Power Unit

INTERMITTENT HP RATING @ 1800 RPM
Nb. ISO 3046 (kW/HP) = 6.5/8.7

Low Speed Open Power Unit Includes: Base Engine, Mounted Top Tank Radiator, Radiator Fan Guard, Mounted Air Cleaner, Muffler, Muffler Guard, Pusher Fan, Fuel Filter w/ Valve, 12 Volt Electric Starter Motor, 45 Amp External Alternator, Mounting Feet, Mounted Control Panel, A-2 Regulation @ 1800 RPM, SAE 5 Housing, C 106 Flywheel

TECHNICAL SPECIFICATIONS:

NO. OF CYLS	2
BORE x STROKE (mm)	75 x 77.6
DISPLACEMENT (cc)	686
OVERALL DIMS. L x W x H (mm)	612 x 529 x 648
MAX. SPEED (RPM)	1800
MIN. CONT. SPEED (RPM)	900
N. ISO 1585 (kW/HP)	7.1/9.5
Nb. ISO 3046 (kW/HP)	6.5/8.7
Na. ISO 3046 (kW/HP)	6.2/8.3
MAX TORQUE (Lb.FT/RPM)	28.0/1800
SPC. FUEL CON (g/kWh)	260
ACT. FUEL CONS (gal/h)	0.47
OIL SUMP CAPACITY (l./Qts.)	1.6/1.7
DRY WEIGHT (kg/lb.)	108/238

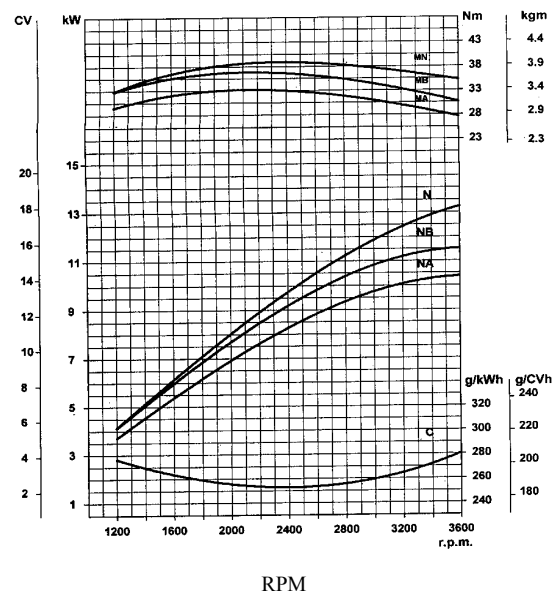

Lombardini USA Inc.
2150 Boggs Road, Building 300, Suite 300
Duluth, GA 30096
Tel: (770) 623-3554 FAX (770) 623-8833
E-mail- lusa@lombardiniusa.com
Internet- <http://www.lombardiniusa.com>

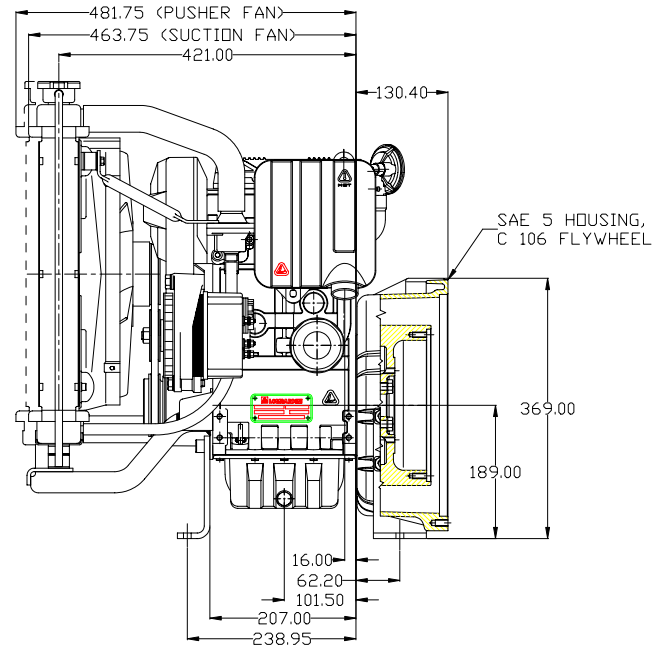
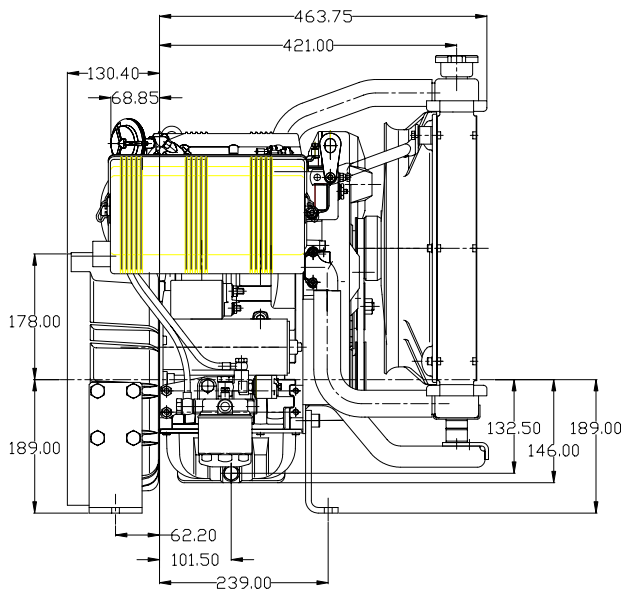

ACCESSORIES AVAILABLE:

- STARTING:** 12V ELECTRIC, OPTIONAL CHARGING SYSTEMS.
- POWER TAKE OFF:** SAE HOUSINGS & DRIVES, SHAFT EXTENSIONS, HYDRAULIC DRIVES.
- AIR CLEANERS:** DRY TYPE.
- EXHAUST FITTINGS:** VARIOUS DESIGN MUFFLERS & MANIFOLDS, MUFFLER GUARDS, LOOSE FLANGES.
- SAFETY SHUTDOWN SYSTEM:** FOR HIGH COOLANT TEMP AND LOW OIL PRESSURE
- FUEL SYSTEM:** REMOTE FUEL FILTERS, FUEL LIFT PUMP.
- COOLING SYSTEM:** ENGINE MOUNTED AND REMOTE RADIATORS, SUCTION AND PUSHER FANS.
- MISC:** MOUNTING FEET, CONTROL PANELS.

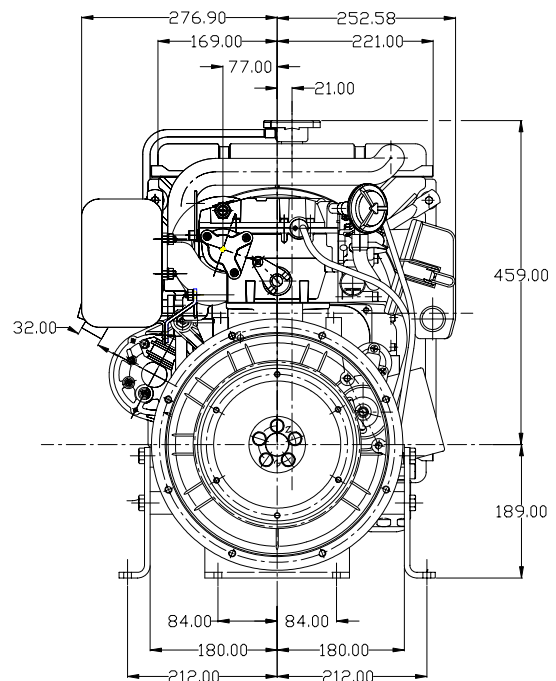

BASIC CONSTRUCTION DETAILS:

4 STROKE DIESEL, LIQUID COOLED, OVERHEAD CAMSHAFT, COUNTER CLOCKWISE ROTATION (PRIMARY PTO), INDIRECT FUEL INJECTION BY UNIT INJECTORS, PRESSURE LUBRICATION BY GEROTOR PUMP, FULL FLOW LUBE FILTER, AUTOMATIC EXTRA FUEL DEVICE FOR COLD START EASE, VARIABLE SPEED GOVERNOR, CAST IRON CRANKCASE WITH REBORABLE CYLINDERS, ALUMINUM ALLOY CYLINDER HEAD WITH REPLACEABLE VALVE GUIDES.